

SETUP INSTRUCTIONS

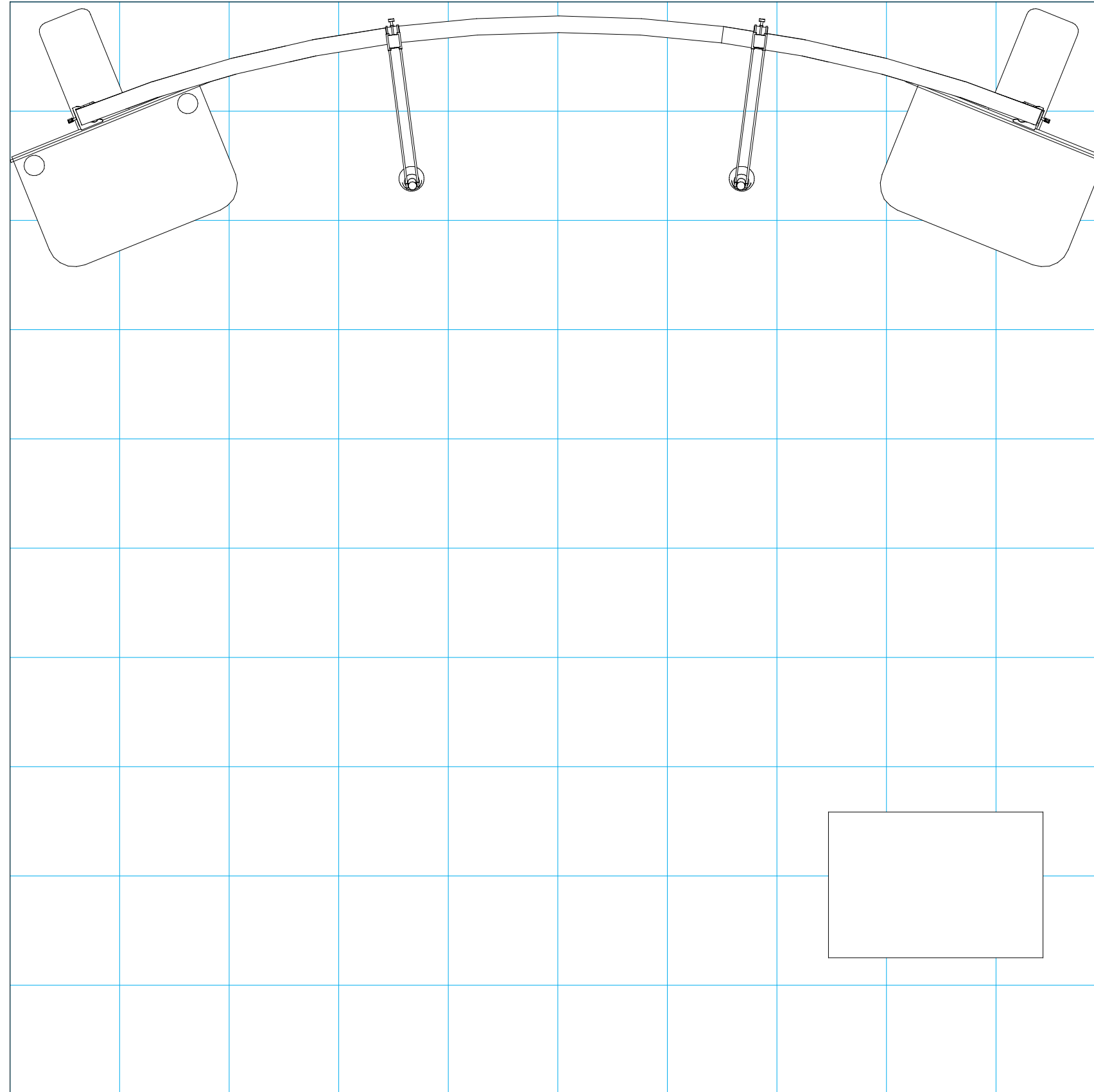

= 1 sq ft

General Setup Instructions

- Read entire setup instruction manual prior to unpacking parts and pieces.
- The setup instructions are created specifically for this configuration.
- Setup instructions are laid out sequentially in steps, including exploded views with detailed explanation for assembly.



Part Identification - Numbering

Cleaning & Packing

- For Cleaning Metal, Plex, & Laminate Parts: Use a **MILD NON-ABRASIVE** cleanser and soft cloth/paper towel to clean all surfaces.
- Keep exhibit components away from heat and prolonged sun exposure.
Heat and UV exposure will warp and fade components.
- Retain all provided Packing Materials. All provided packing materials are for ease of repacking & component protection.



Engaged Lock



WARNING



DO NOT USE POWER TOOLS



ALL CONNECTIONS MUST BE TIGHTLY SECURED

Disassembly

- For loss prevention, keep all knobs & connectors attached to extrusions during disassembly.

Straight Connection

When assembling frame, first attach all **straight connectors**, then attach **corner connectors**.

- 1) Place extrusions end-to-end.
- 2) Loosen all knobs, then slide **straight connector** across the seam of extrusions.
- 3) Tighten all knobs to secure connection.



Slide connector across seam of extrusions.
Tighten all knobs.



Disassembly

- 1) Loosen all knobs.
- 2) Slide connectors off of one extrusion.
- 3) Tighten knobs to prevent loss during packing & shipping.

Keep straight connectors in groove of extrusion. Do not remove connectors during disassembly.

All knobs must be tightened securely to ensure a proper connection.

Corner Connection

- 1) Loosen knobs, then slide vertical extrusions onto **corner connectors** of **lower** horizontal extrusion.
- 2) Slide **corner connectors** of **upper** horizontal extrusion into grooves of vertical extrusions.
- 3) Tighten all knobs to secure connection.

Disassembly

- 1) Loosen knobs on vertical extrusions.
- 2) Slide the vertical extrusions off of **corner connectors** on lower and upper horizontal extrusions.



Adjust connectors if necessary to prevent gaps in connection.



COMPLETED ASSEMBLY

All knobs must be tightened securely to ensure a proper connection.

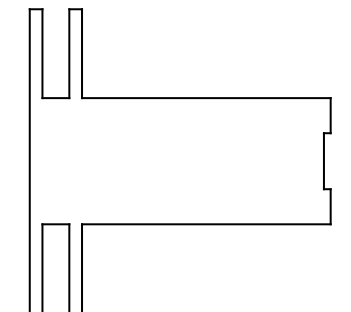

TSP49 Profile

The Perfect Fit

SEG Graphic Installation *in 3 Steps*

STEP 1: Attach Corners



STEP 2: Attach Middle



STEP 3: Attach Sides



Insert narrow side of silicone welt into the channel at corner 1, with fabric to the outside.

Repeat for opposite corner 2, then corner 3, then corner 4.

Once corners are attached, press the middle of edge 1 into the channel. Then press middle of edge 2 into the channel on opposite side.

Repeat with edge 3 & 4.

Once the middle of sides are attached, fully press the silicone welt into the channel, between center and corner at location 1. Repeat the process between center and corner at location 2.

Do the same for welt on opposite side, at locations 3 & 4. Then repeat for locations 5 & 6 and 7 & 8.

Once the welt is fully inserted on all sides, smooth out edges as needed for a perfect fit.



To remove the graphic from the frame, locate the fabric **pull tab**. Gently pull on the tab to remove the graphic.

Install video:



Top View of Each Level



Level 1
(Bottom level)

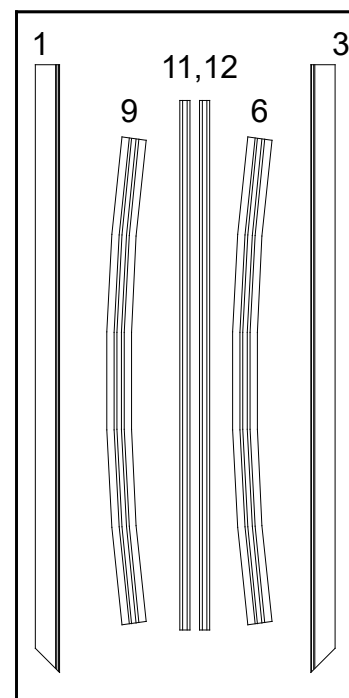

Level 2

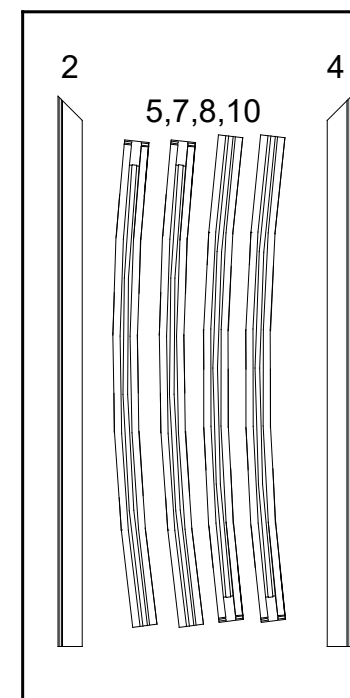

Level 3

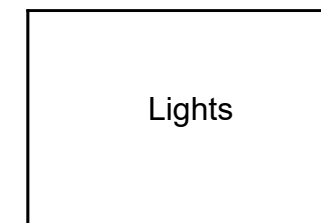
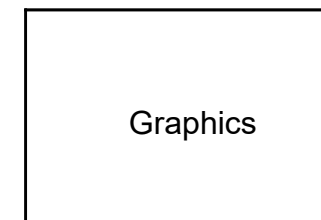

Top View of Each Level

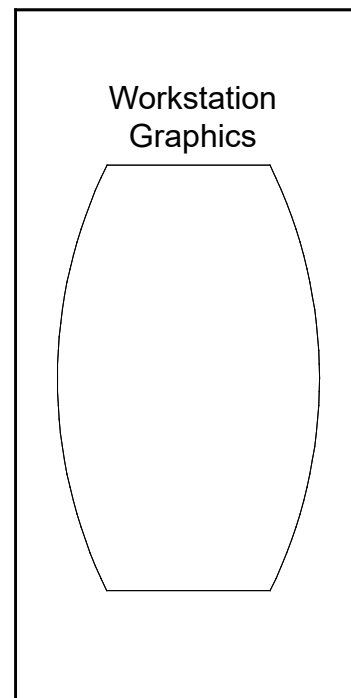

Level 1
(Bottom level)

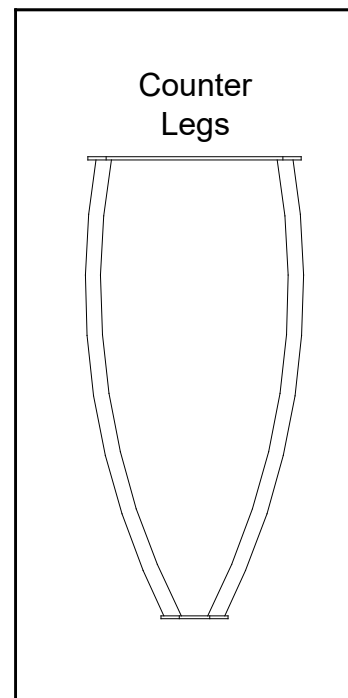

Level 2

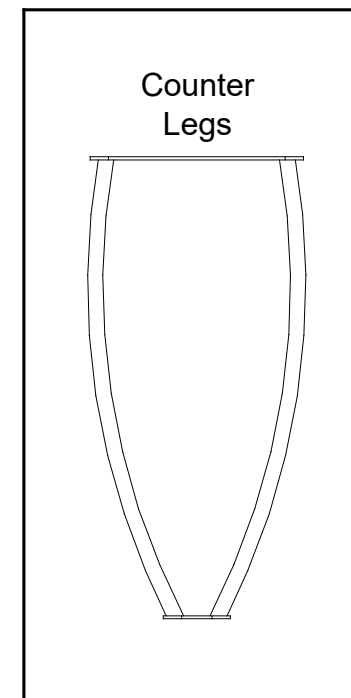

Level 3

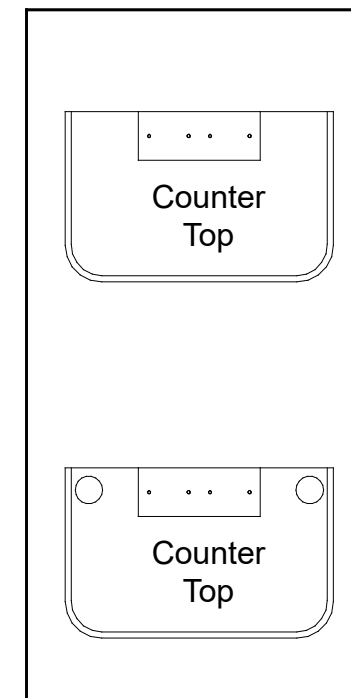

Level 4

Top View of Each Level

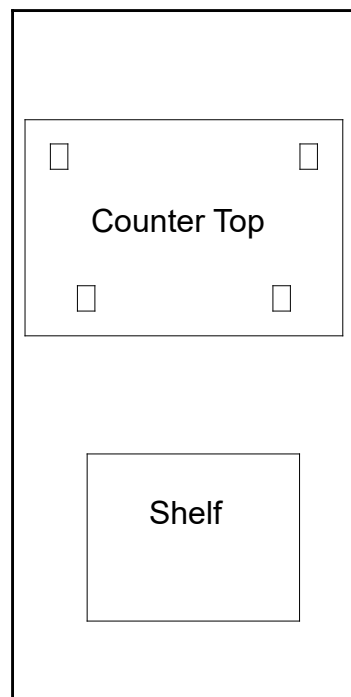

Level 1
(Bottom level)

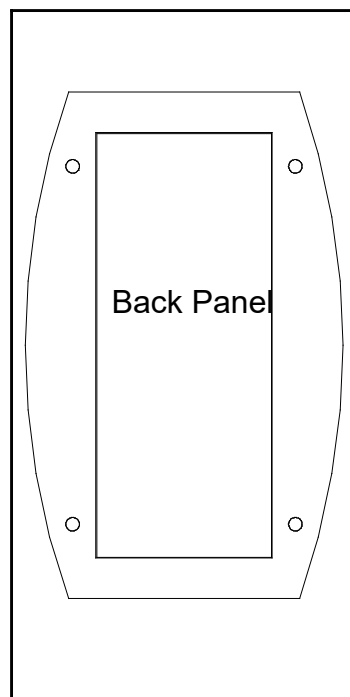

Level 2

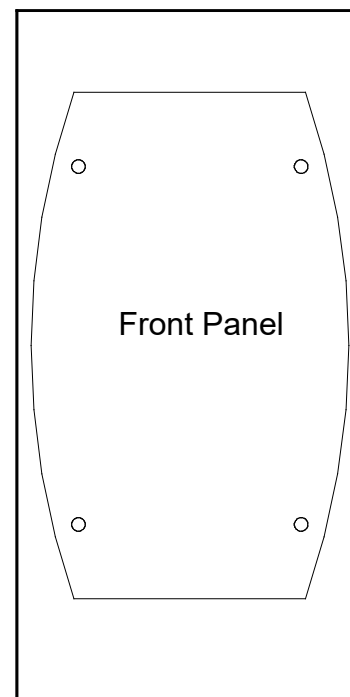

Level 3

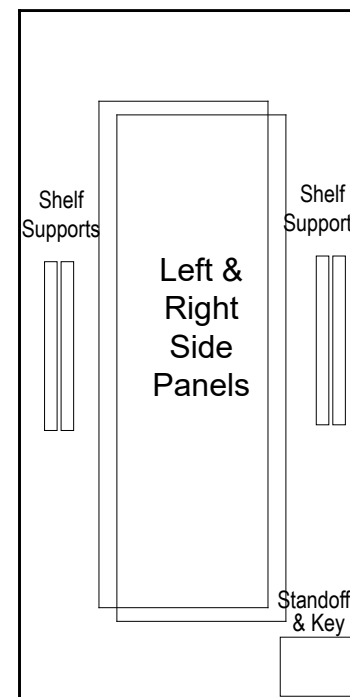

Level 4

Item	Qty.	Description
1	1	45"h TSP49 Vertical Extrusion
2	1	41"h TSP49 Vertical Extrusion
3	1	45"h TSP49 Vertical Extrusion
4	1	41"h TSP49 Vertical Extrusion
5	1	36.166"w TSP49 curved Horizontal Extrusion
6	1	36.166"w TSP49 curved Horizontal Extrusion
7	1	36.166"w TSP49 curved Horizontal Extrusion
8	1	36.166"w TSP49 curved Horizontal Extrusion
9	1	36.166"w TSP49 curved Horizontal Extrusion
10	1	36.166"w TSP49 curved Horizontal Extrusion
11	1	41.209"h Z45 Vertical Extrusion
12	1	41.209"h Z45 Vertical Extrusion
13	2	6" x 22" Base Plate w/ flange

Steps:

Refer to the [Tool-less Frame Assembly general information page](#).

- 1) Assemble vertical extrusions [1-2], [3-4], [11-12] & horizontals [5-6-7], [8-9-10] together, using [Tool-less Spline Connectors](#) labeled [X] & [Z].
- 2) Connect vertical assemblies [1/2], [3/4] between horizontal assemblies [5/6/7], [8/9/10], using [Tool-less Corner Connectors](#) labeled [A].
- 3) Install Base Plates [13] to bottom corners of frame assembly as shown. See [Base Plate Attachment](#) detail.
- 4) Lift frame to upright position, then connect vertical assembly [11/12] between horizontal assemblies [5/6/7], [8/9/10] using [Connection Lock w/ Knob](#).

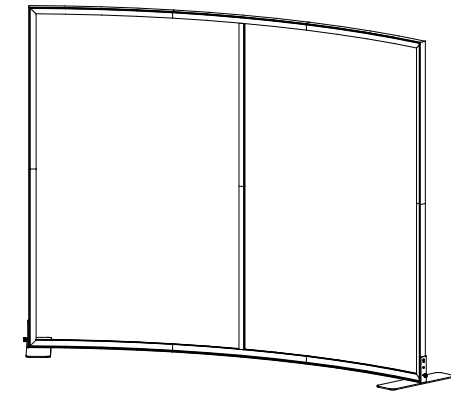

When assembled

Assemble frame flat on ground.

*** Tool-less Spline Connector**

1. Place extrusions end-to-end.
2. Slide tool-less connectors across seam of extrusions.
3. Tighten all knobs to secure connection.

X = Straight spline
Z = Curved spline

*** Tool-less Corner Connector**

1. Slide extrusion onto Corner Connector.
2. Tighten all knobs to secure connection.

A = 90° Connector

Keep corner connectors attached to horizontal extrusions.

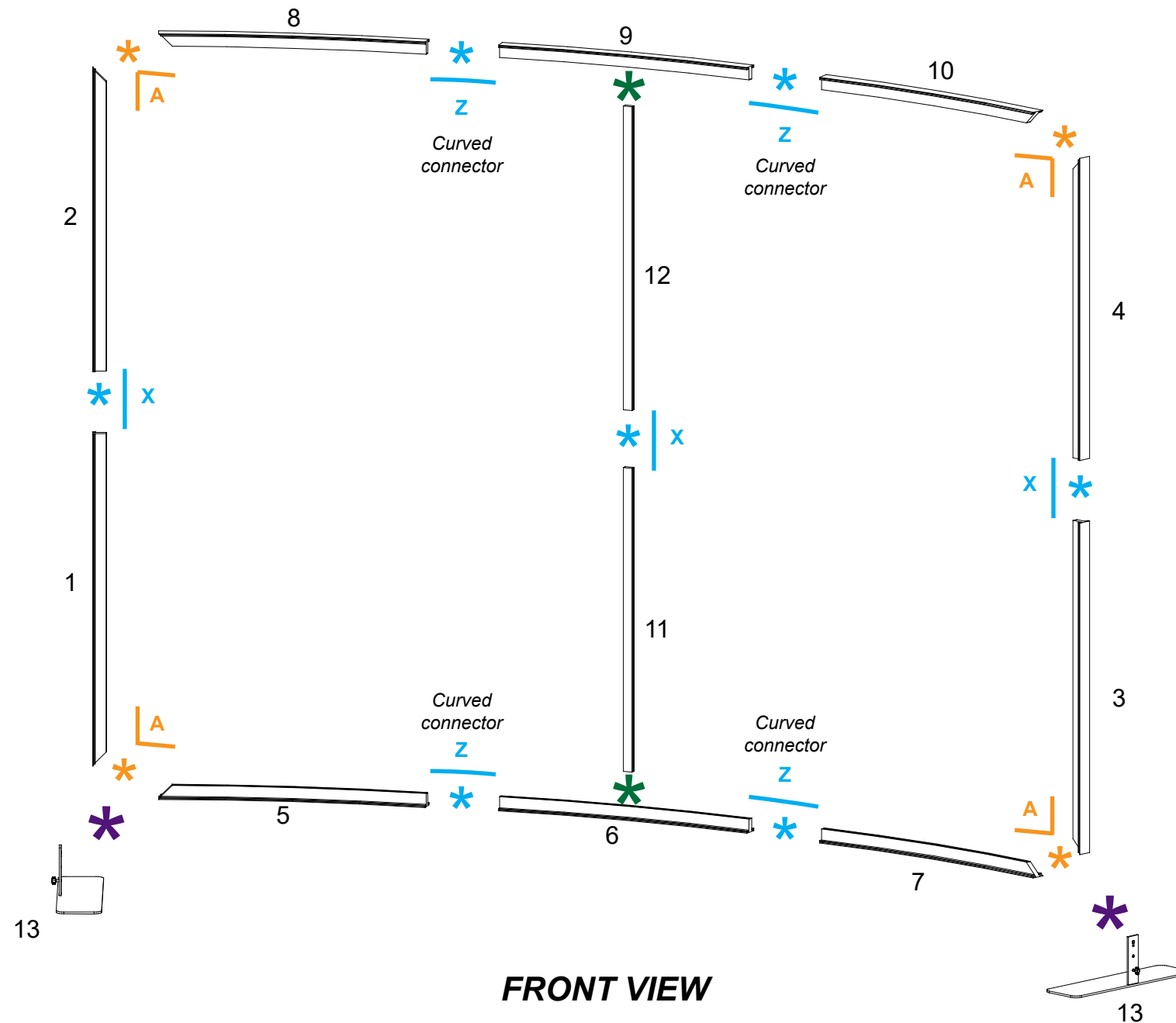

FRONT VIEW

*** Connection Lock w/ Knob**

Knobs face **back** of assembly.

BACK VIEW

*** Base Plate Attachment**

- 1) Place key hole over bolt on panel & slide down.
- 2) Twist knob to secure connection.

Base Plate

SEG Graphic Installation

STEP 1: Attach Corners

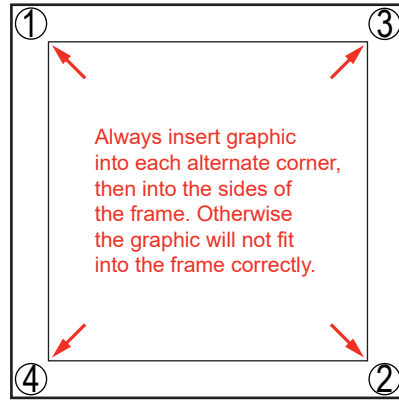

Insert narrow side of silicone welt into the channel at corner 1, with fabric to the outside.

Repeat for opposite corner 2, then corner 3, then corner 4.



STEP 2: Attach Middle

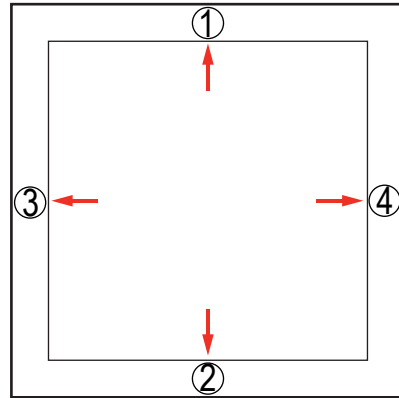

Once corners are attached, press the middle of edge 1 into the channel. Then press middle of edge 2 into the channel on opposite side.

Repeat with edge 3 & 4.

Once the middle of sides are attached, fully press the silicone welt into the channel, between center and corner at location 1. Repeat the process between center and corner at location 2.

STEP 3: Attach Sides

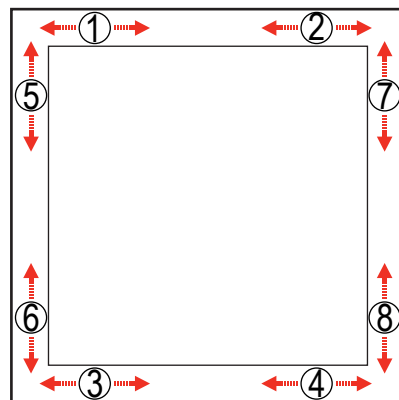

Do the same for welt on opposite side, at locations 3 & 4. Then repeat for locations 5 & 6 and 7 & 8.



Steps:

1) Apply SEG Graphic to front of assembled frame.

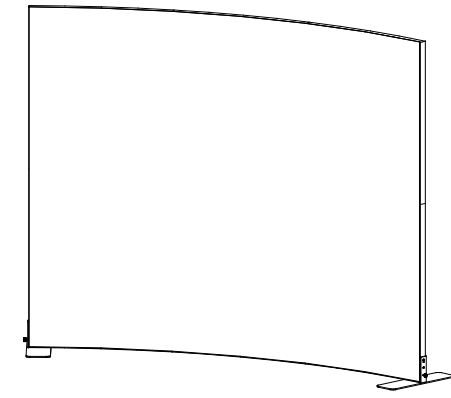

When assembled

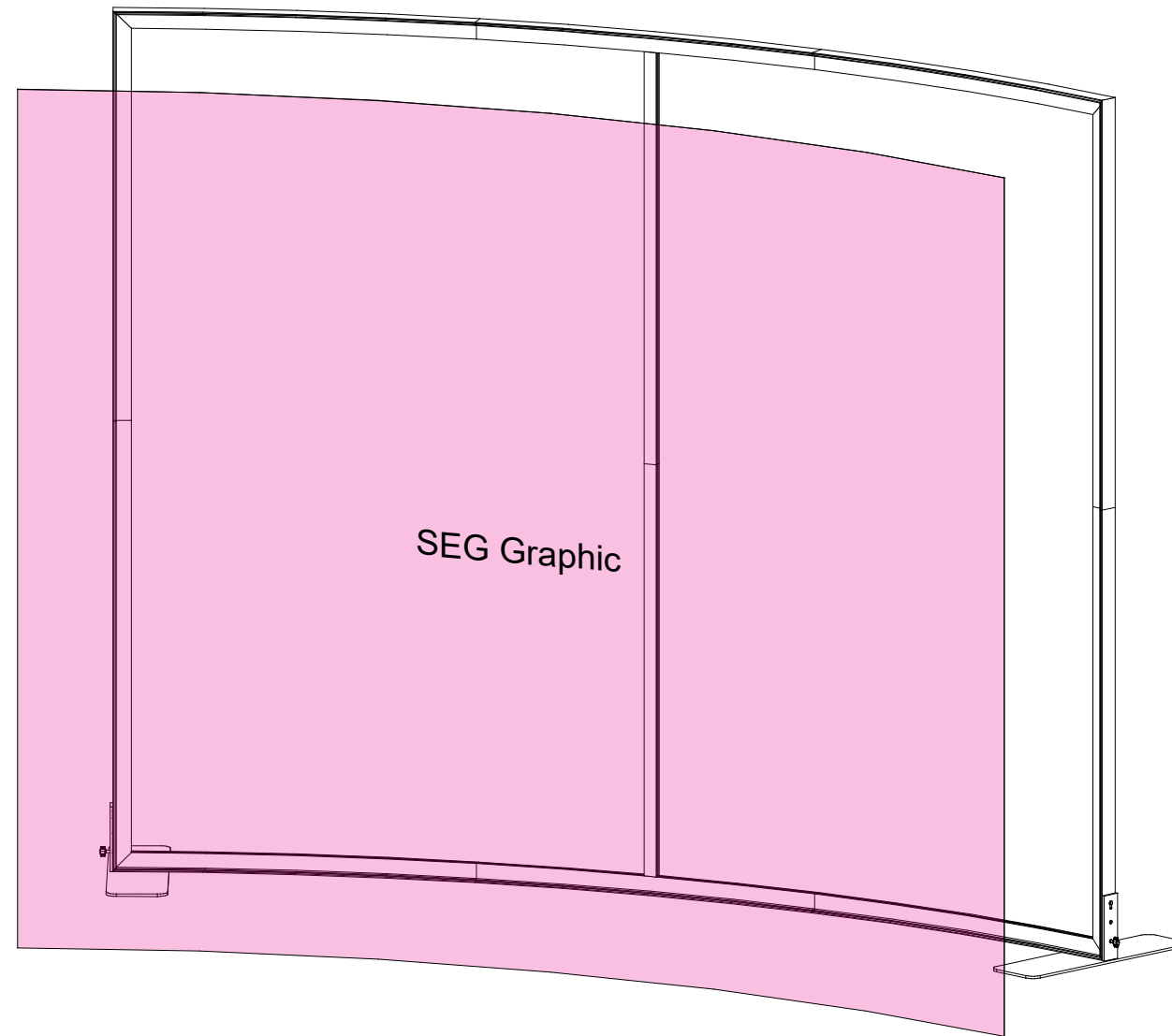

FRONT VIEW

*** Workstation Bracket Attachment**

① Hook the Mounting Bracket over the vertical extrusion.

② Slide bracket forward, then down onto V4 connector.
V4 connectors stay permanently attached to vertical extrusion.

③ Tighten thumb screws to secure connection to inside of frame.

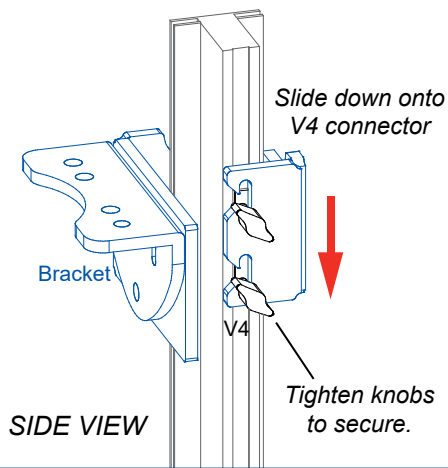
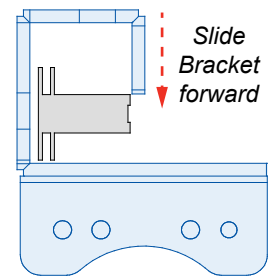
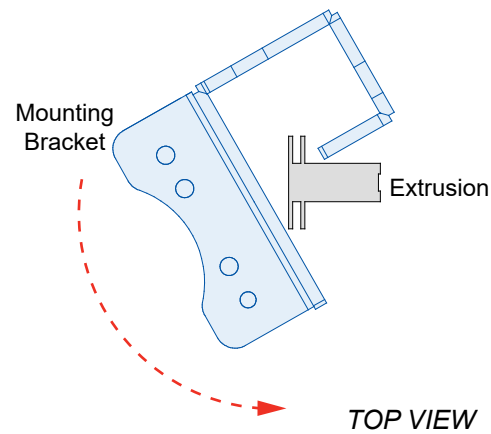

Steps:

- 1) Attach Workstation Mounting Brackets to backwall verticals as shown. See [Workstation Bracket Attachment](#) detail.
- 2) Assemble Workstation legs & counter tops to brackets. See [Workstation Assembly](#) detail.
- 3) Affix **Graphics** to front of workstation assemblies, using Velcro.
- 4) Attach Lights to top of backwall as shown. See [Light Attachment](#) detail.

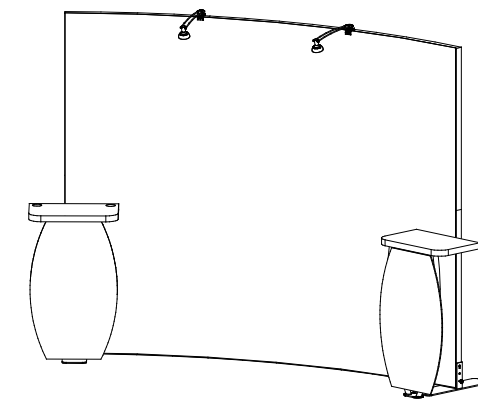

When assembled

Workstation Assembly

1) Attach threaded studs on underside of Counter Top to Counter Legs; secure with wing nuts.

2) Connect Counter Top to Mounting Bracket, using wing nuts.

3) Attach power cords to wireless chargers.
Keep cords attached to underside of counter top.

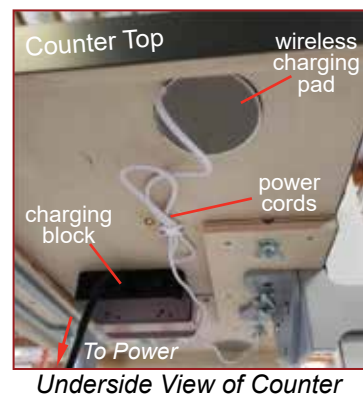
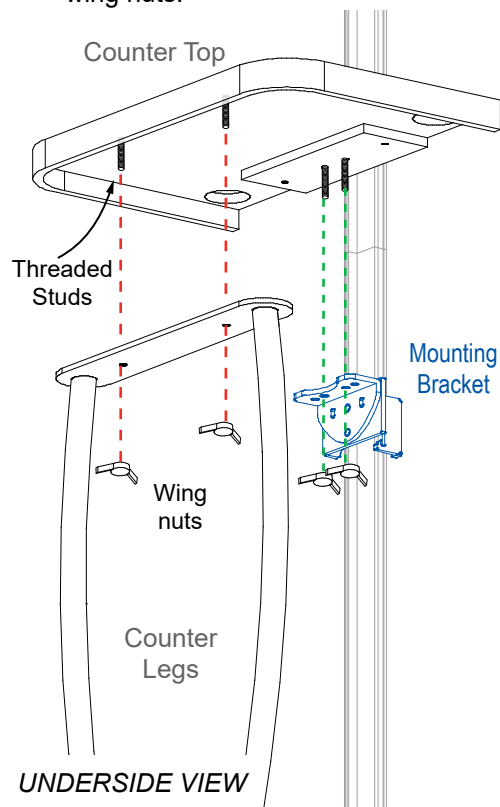

*** Light Attachment**

Attach clamp of stem light to top of horizontal extrusion where desired.

Twist knob on back to tighten in place.

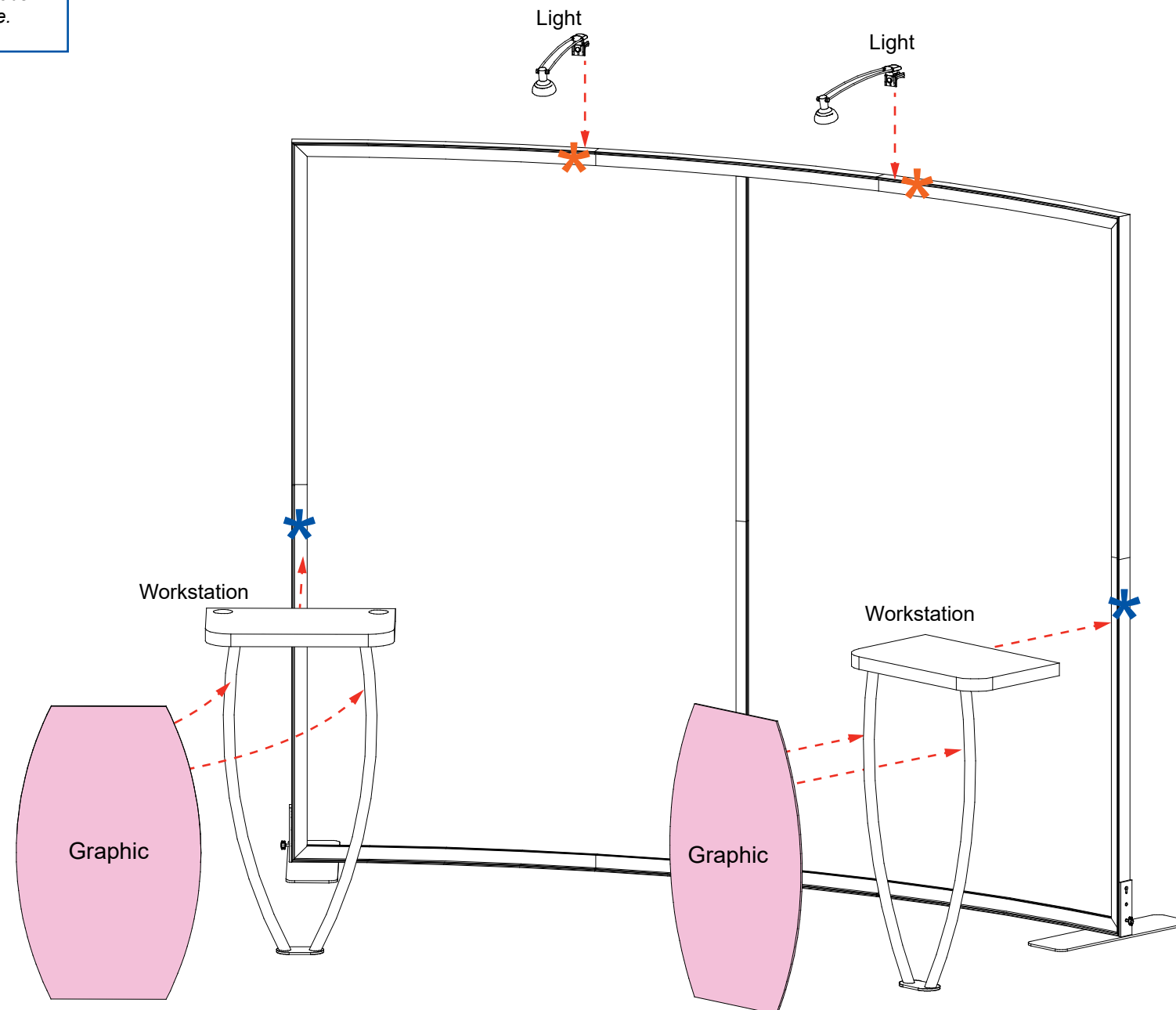
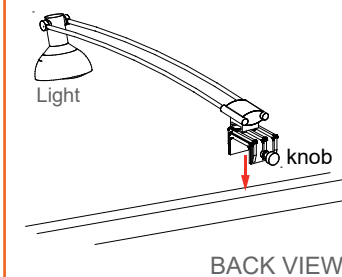

* Floating Graphic Attachment

① Hook the Graphic Bracket onto the extrusion & snap into place.

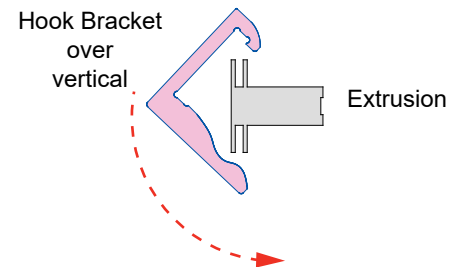

TOP VIEW

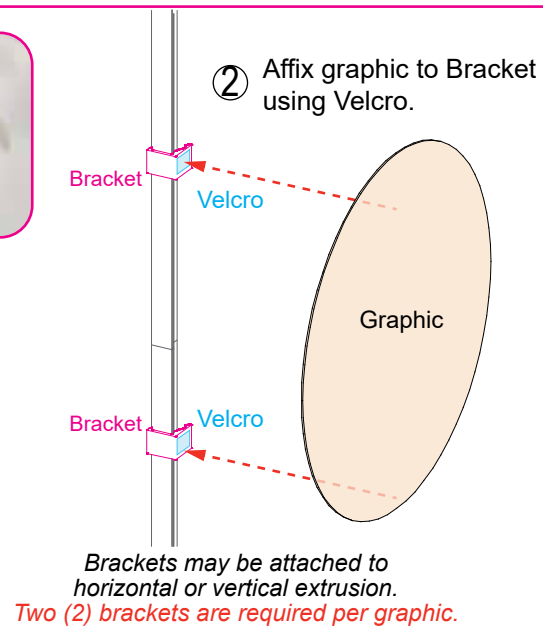
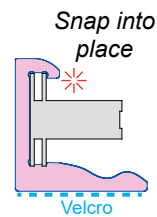

Steps:
1) Connect Floating Graphics to backwall using brackets. See [Floating Graphic Attachment](#) detail.

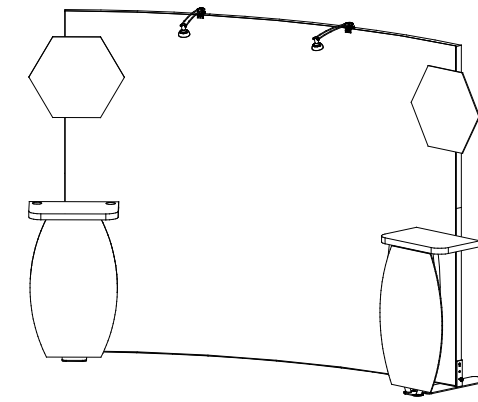

Completed Assembly

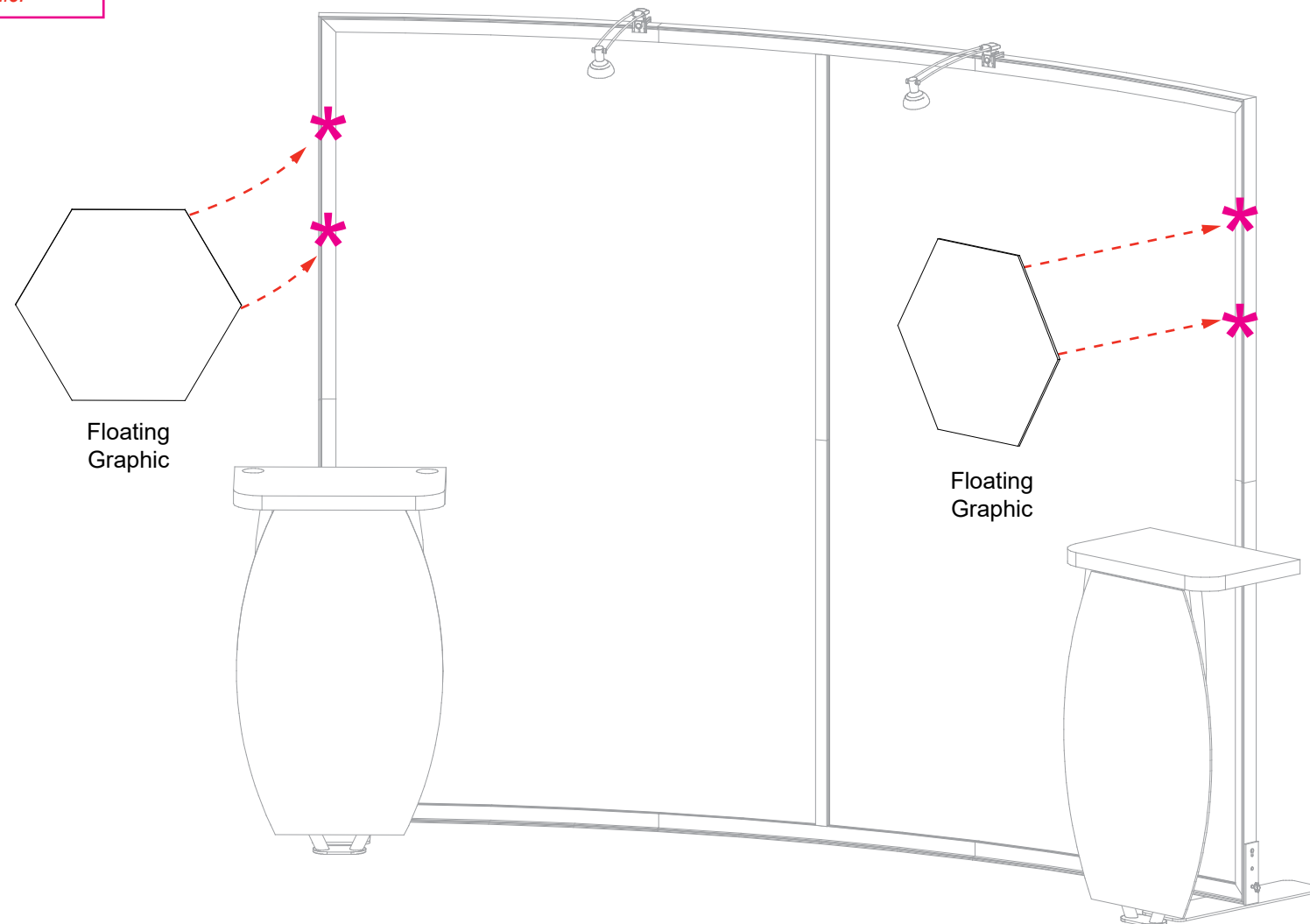

Steps:

- 1) Use screw caps to secure side panels to front & back panels.
- 2) Connect shelf supports with Velcro inside of panels, then place shelf on top of supports.
- 3) Attach Counter Top to assembled pedestal base. See Counter Top Attachment detail.

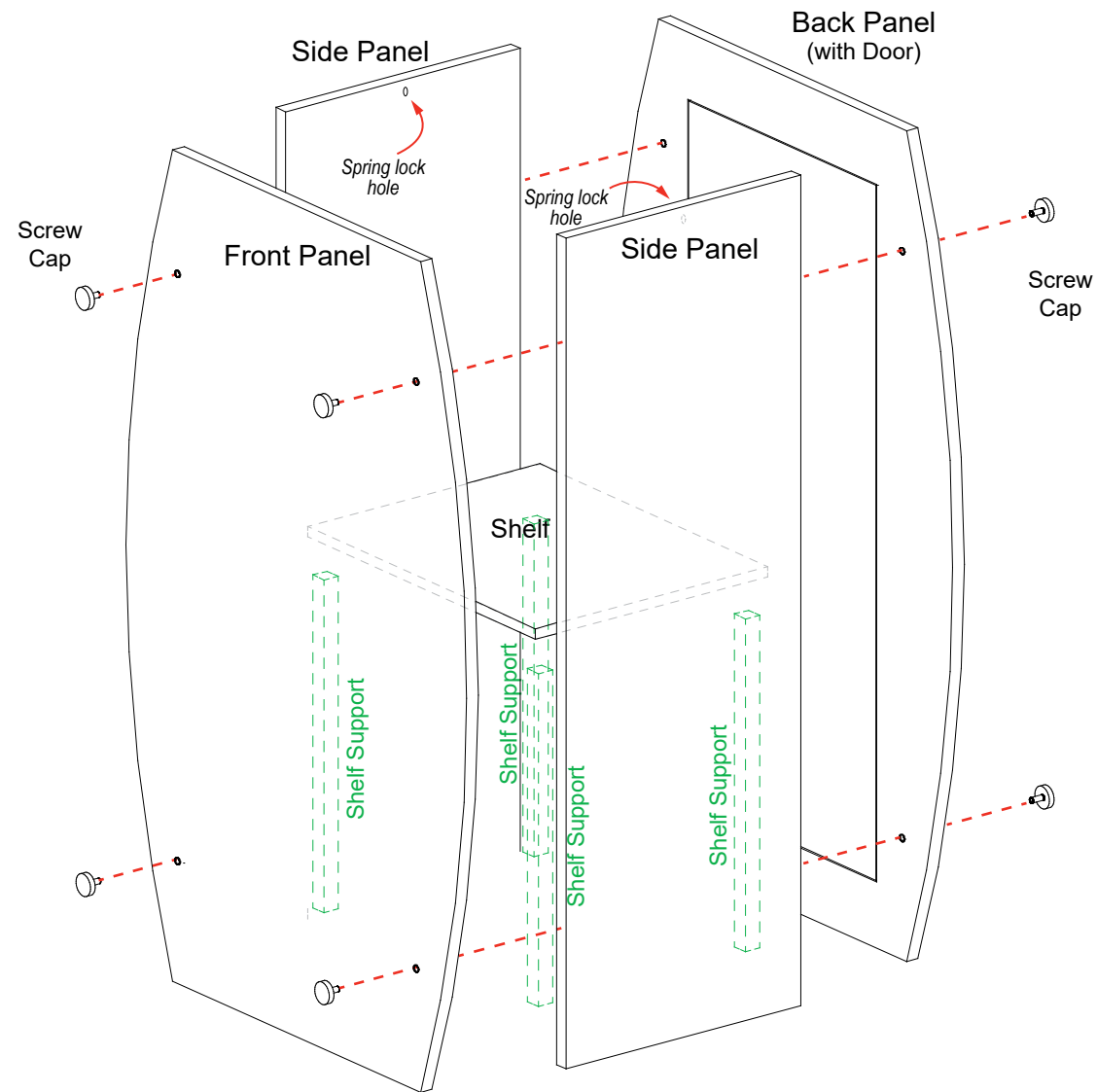

Pedestal Base Assembly

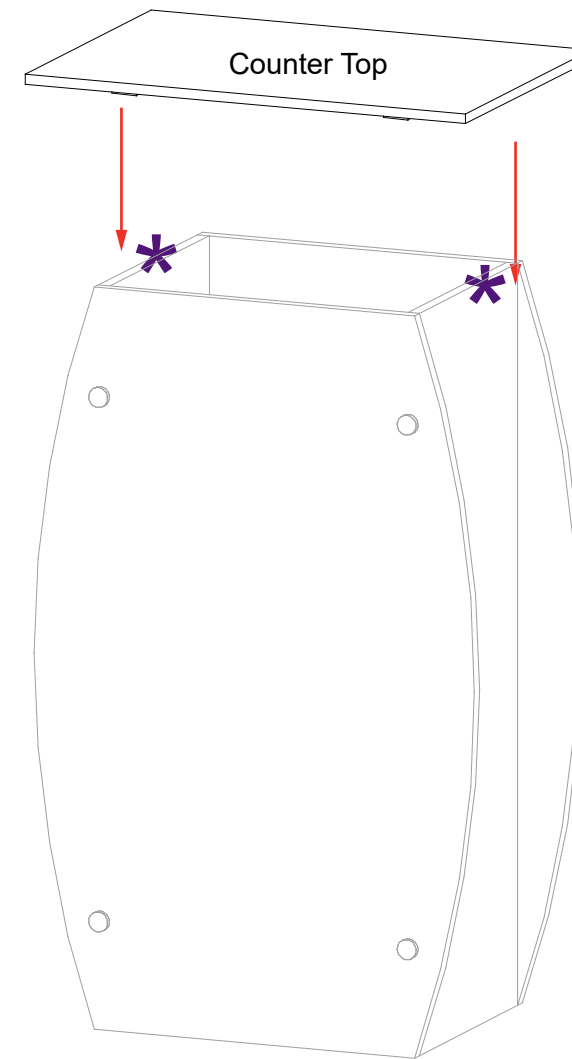

Pedestal Top Attachment

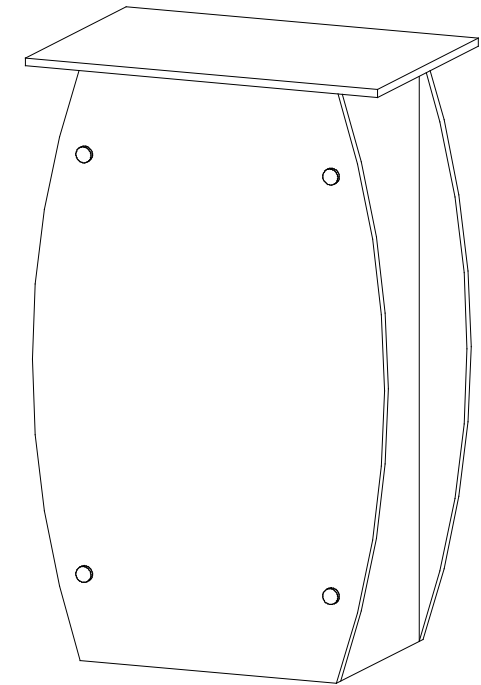

When assembled

